

uni_door

Introduzione

Nel vasto panorama dell'architettura contemporanea, il pannello in alluminio si erge come elemento essenziale nella costruzione di portoncini d'ingresso, simbolo di modernità e funzionalità. Questo catalogo non solo celebra la qualità e l'innovazione dei nostri portoncini, ma si immerge anche nella dimensione metafisica che essi evocano.

La metafisica, con la sua ricerca dell'essenza oltre l'apparenza, trova una perfetta corrispondenza nei nostri portoncini. Come Giorgio de Chirico ha trasformato le sue piazze vuote e i suoi edifici in enigmi senza tempo, così i nostri portoncini trasfigurano l'ingresso di ogni edificio, offrendo una soglia tra il mondo tangibile e quello dell'immaginazione.

I nostri prodotti si ispirano anche all'approccio di architetti come Aldo Rossi, che nelle sue

opere ha saputo coniugare la funzionalità con una profonda riflessione filosofica sullo spazio e sul tempo. Rossi ha trasformato l'architettura in una narrazione, dove ogni elemento è un simbolo carico di significato.



















Ogni portoncino che progettiamo è una porta verso un mondo metafisico, dove la forma incontra l'essenza e il quotidiano si eleva a poesia. L'ingresso diventa non solo una scelta estetica e tecnica, ma una dichiarazione di intenti, un invito a riflettere su ciò che c'è oltre l'apparenza.

Speriamo che questo catalogo vi ispiri e vi conduca verso nuove frontiere dell'architettura, dove il materiale e il metafisico si fondono in una perfetta armonia.

Tecnologia e creatività

La gamma uni_door di Uniform è pensata per rispondere ai requisiti di qualità e sicurezza lasciando ampia libertà di comporre l'ingresso secondo i gusti e le esigenze dei clienti.

Nelle collezioni in.ciso | in.serto | in.luce | in.castro abbiamo giocato con pieni e vuoti, con incisioni, inserti, decori, lavorazioni, colori e materiali.

MATERIALE	COLLEZIONE	APERTURA	
		BATTENTE	PIVOT *
Alu 	in.ciso		
WoodAlu 			
Alu 	in.luce		
Alu 	in.serto		
WoodAlu 			
Alu 	in.castro		
WoodAlu 			

* Apertura Pivot realizzabile su disegno previa verifica del modello. Potrebbero essere necessarie variazioni estetiche rispetto alla decorazione del pannello a battente.



Pannello in Alluminio Esterno e Interno



Pannello in Alluminio Esterno
Pannello in Legno Interno





IN.CISO

IN.CISO

Le incisioni a U disegnano sulla superficie del pannello figure e decori che donano libertà creativa e progettuale.

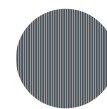

Alu



Battente



Bilico



WoodAlu



Battente

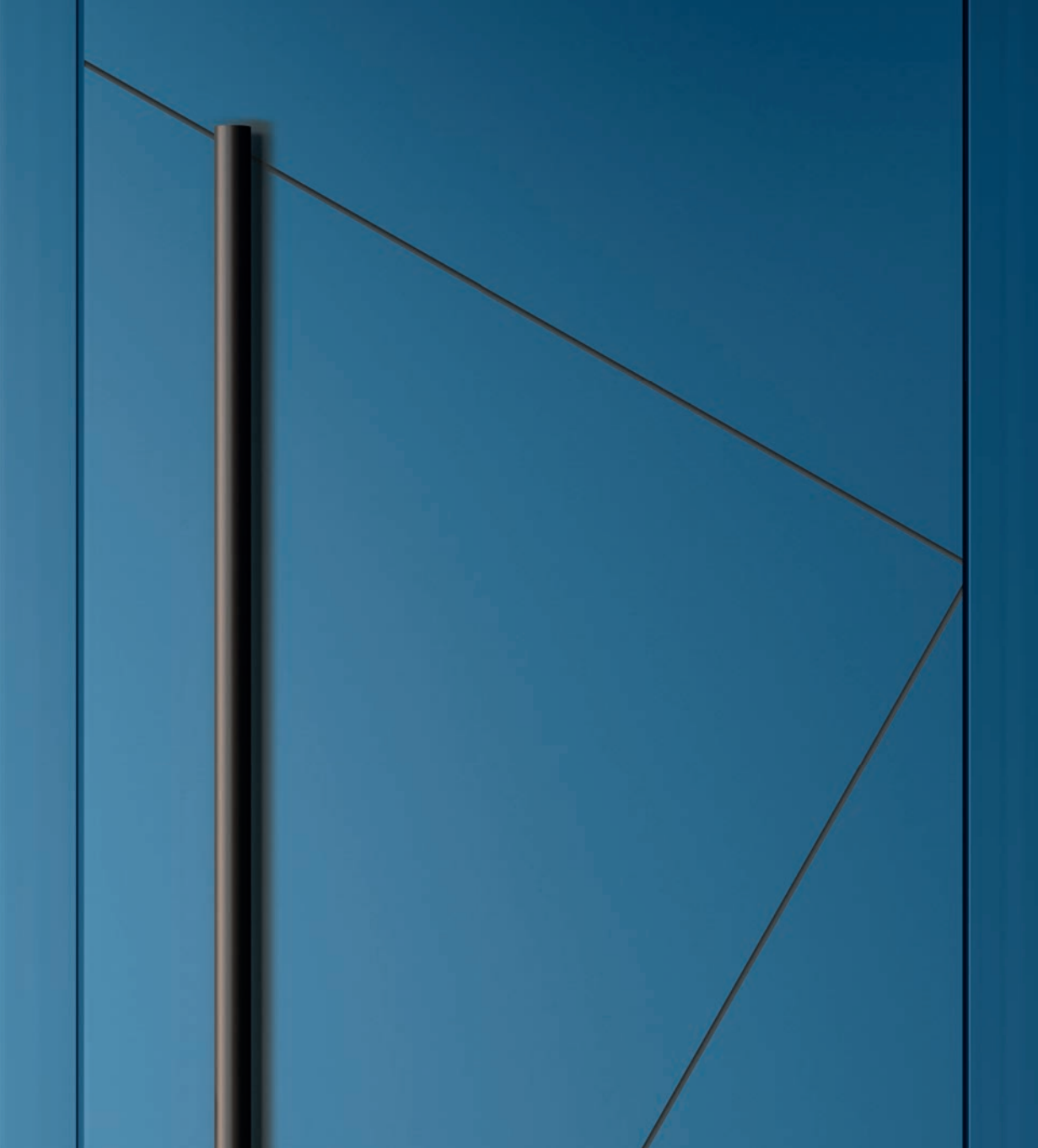



40102



40101

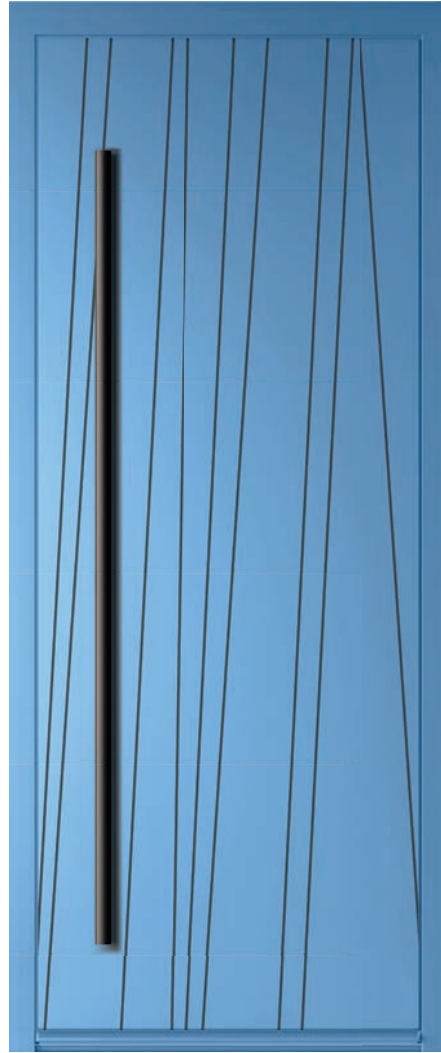

40105

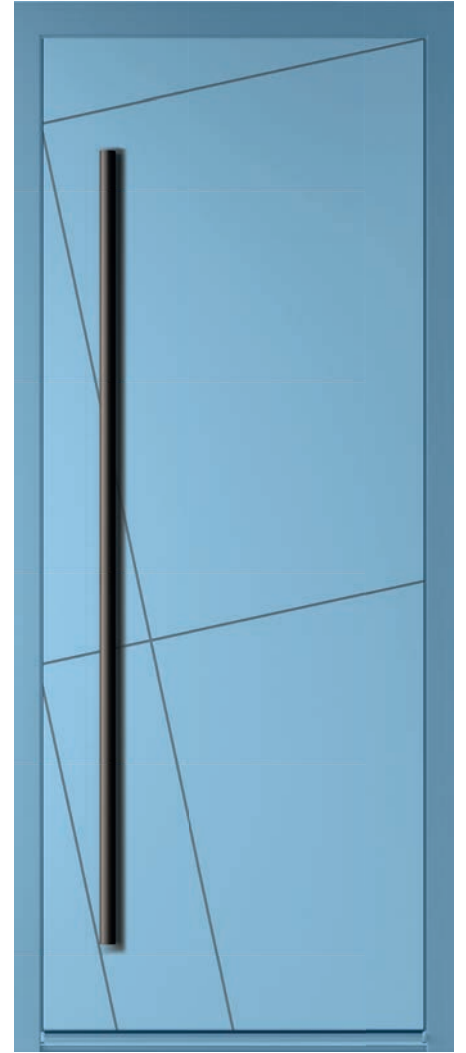

40104



40103



40106



40107



40108



INCISIONE

Larghezza: 10 mm

Profondità: 0,8 mm

Spessore lamiera: 1,5 mm





in.luce

IN.LUCE

Aggiungere porzioni di vetro nel portoncino d'ingresso significa illuminare ingressi e zone dell'abitazione particolarmente in ombra.

La luce entra nella casa attraverso vetri trasparenti oppure satinati per una maggiore privacy.

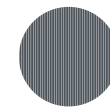

Alu



Battente

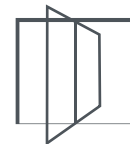

Bilico



40109



40111



40112



40113



40114



40115



40116



40110







in.serto

IN.SERTO

Le applicazioni della collezione in.serto donano un tocco di eleganza al tuo portoncino d'ingresso.

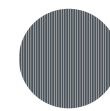

Alu



Battente



Bilico



WoodAlu



Battente



40117



40118



40125



40119

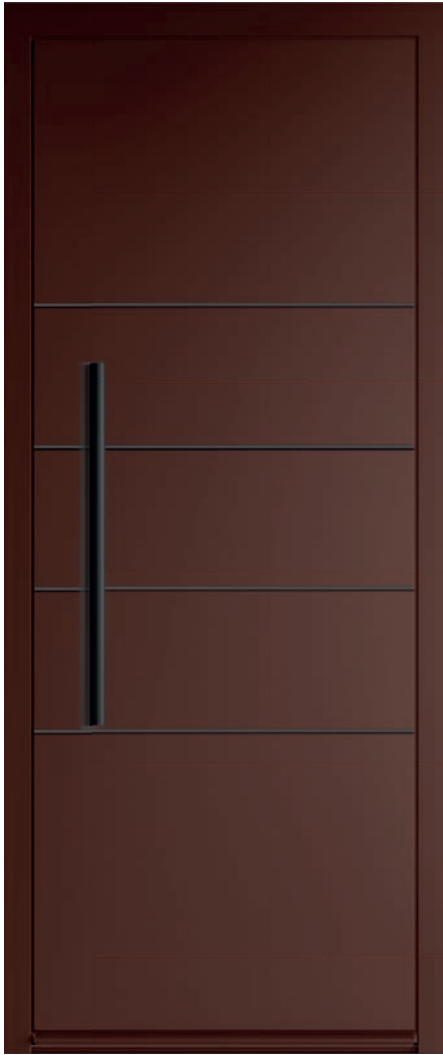

40120



40126



40121



40124



PIATTINA

Spessore: 0,6 mm

Larghezza variabile: 10/20/30/40/50 mm

Colore piattina: nero matt



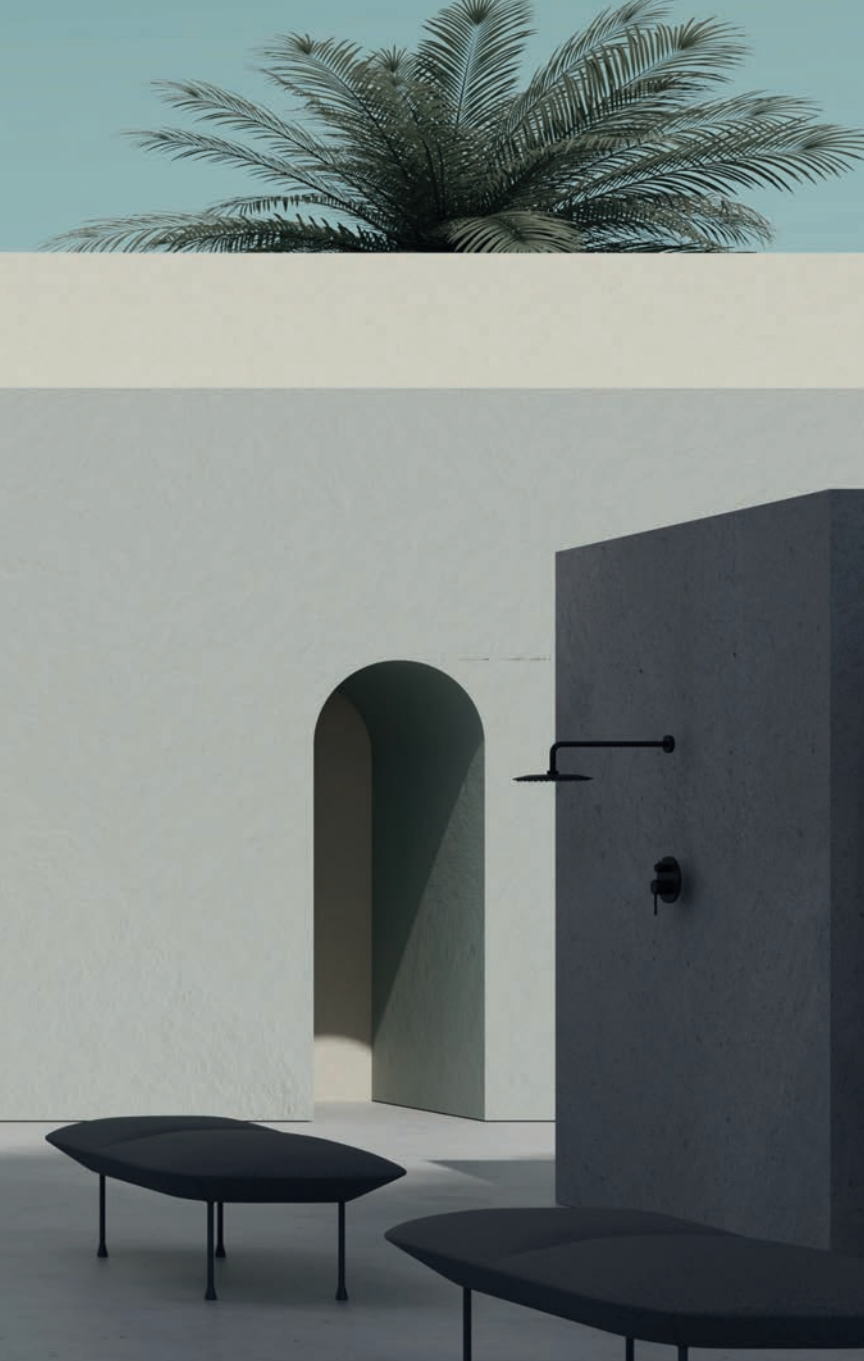

In.castro

IN.CASTRO

L'incastro arricchisce e dona carattere al tuo portoncino d'ingresso.

A seconda della colorazione esterna è possibile creare motivi a contrasto dal carattere deciso o soluzioni dalle cromie ton sur ton per un effetto più delicato e chic.

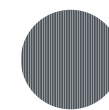

Alu



Battente



Bilico



WoodAlu



Battente



40135



40134



40133



40132



40131



40129



40127



40128

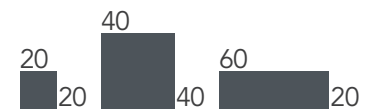

TUBOLARE

Le applicazioni tubolari della collezione in.castro donano tridimensionalità al portoncino creando effetti ottici dinamici e sofisticati.

Colore tubolare: qualsiasi finitura secondo cartella colore.



in.serto composizione modelli
Vista in sezione delle applicazioni

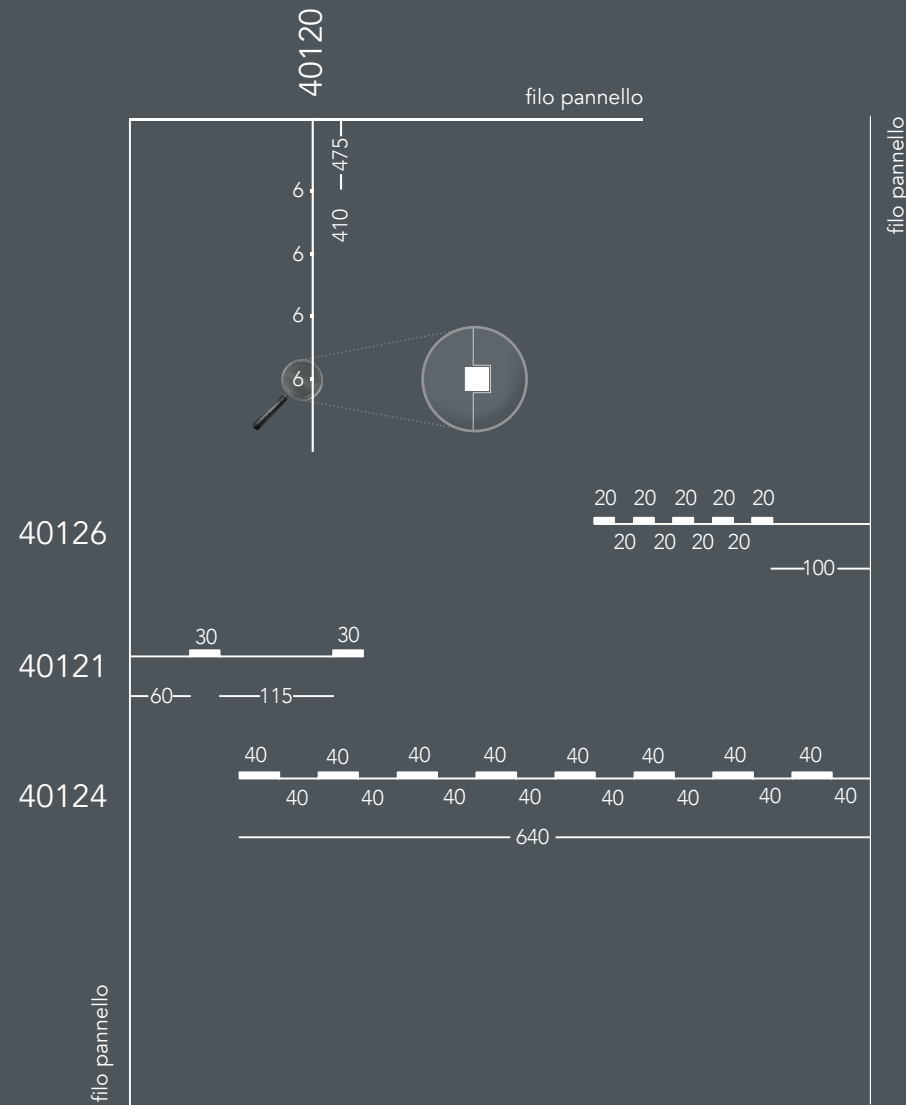
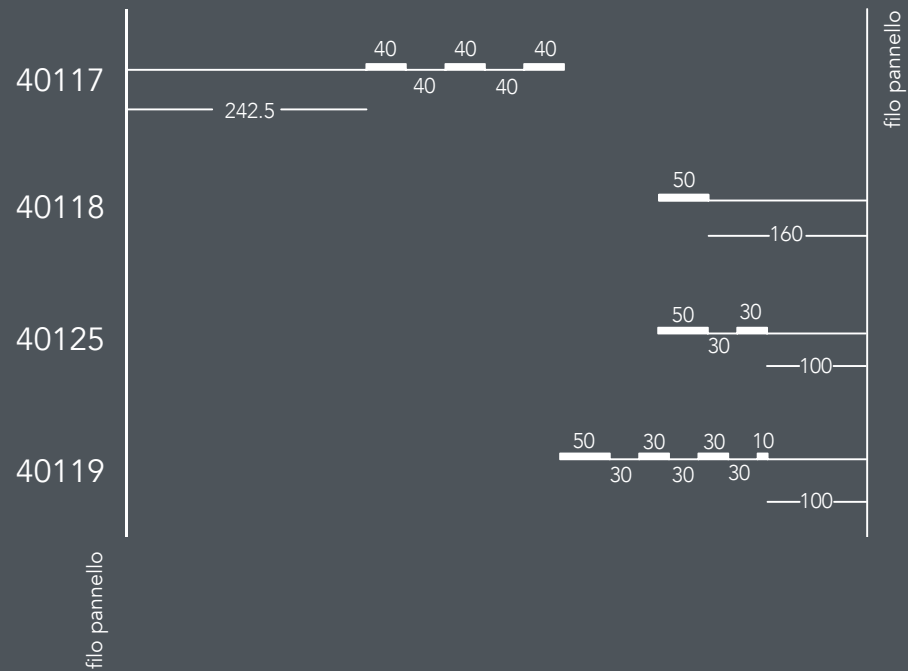

in.castro composizione modelli
 Vista in sezione delle applicazioni

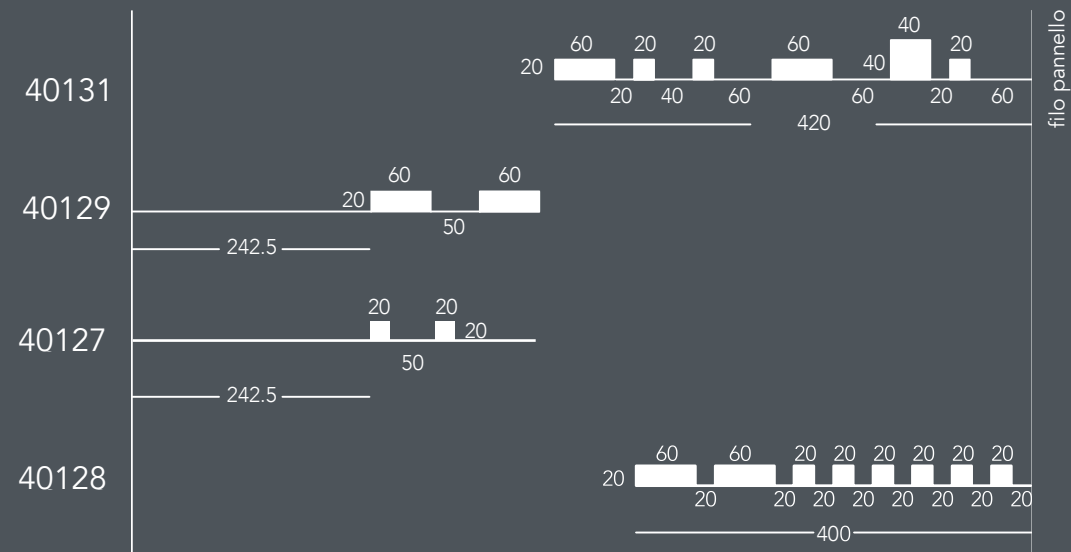
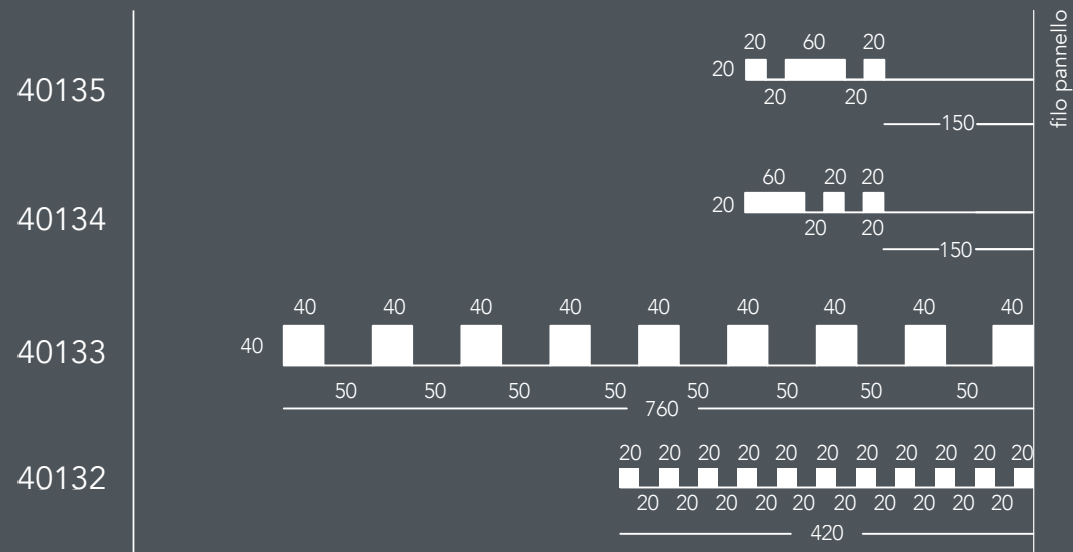

i tubolari della collezione in.castro sono chiusi all'estremità con tappi neri.



TotalLook

TOTAL LOOK

Pannello interno disponibile con finitura legno delle collezioni ICONA, NATURA ed in TRANCIATO DI ROVERE spazzolato grezzo, fornito smontato da verniciare.

Possibilità di fornire il portoncino anche senza il pannello interno che potrà essere realizzato dal cliente con spessore di 12mm.

Finiture ICONA TotalLook

FPL IC 059

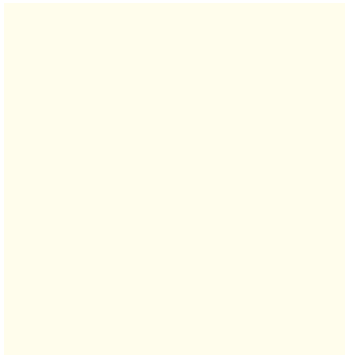

TALCO

FPL IC 050



SALE

FPL IC 051



PERLA

FPL IC 052



ROCCIA

FPL IC 053

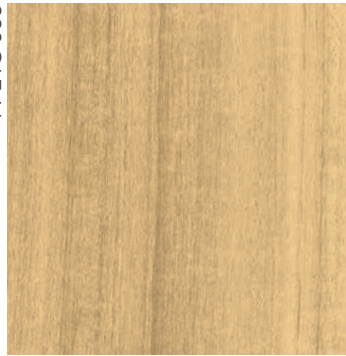

CORDA

FPL IC 054

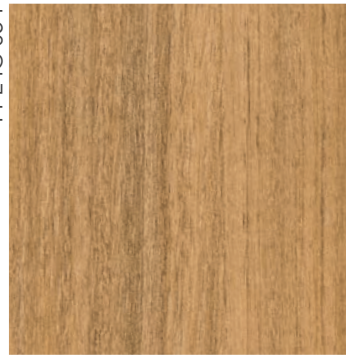

GRANO

FPL IC 060



QUERCIA

FPL IC 055

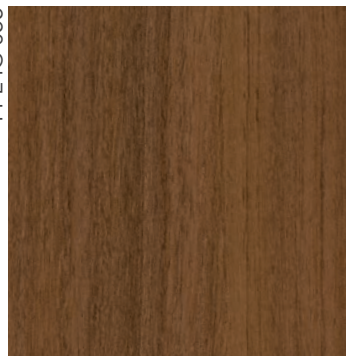

CORTECCIA

FPL IC 058



RUGGINE

FPL IC 056



TORBA

FPL IC 057

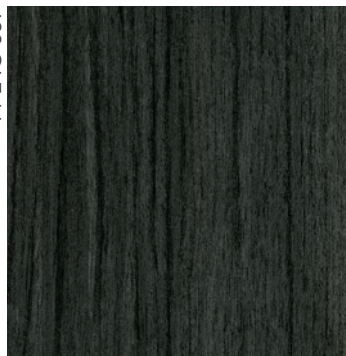

LAVICA

Finiture NATURA TotalLook

FPL TR 018

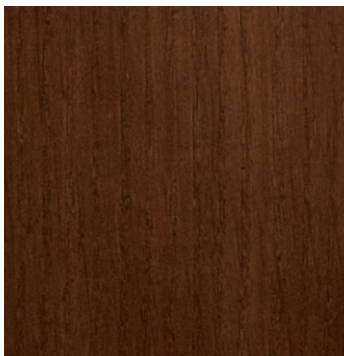

TERRA

FPL TR 017

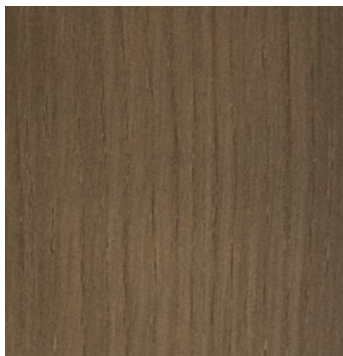

SAVANA

FPL TR 016



MALTO

FPL TR 015



NATURALE

FPL TR 004

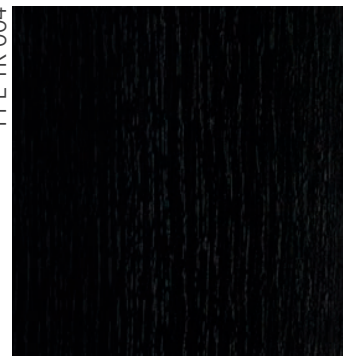

LACCATO NERO
PORO APERTO

FPL TR 003



LACCATO GRIGIO PERLA
PORO APERTO

FPL TR 002



LACCATO GRIGIO PERLA
PORO APERTO

FPL TR 001



LACCATO BIANCO
PORO APERTO

FPL LC 043



MDF LACCATO OPACO
GRIGIO PERLA

FPL LC 042

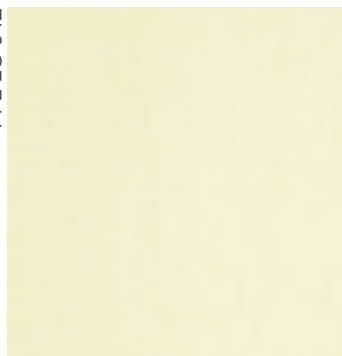

MDF LACCATO OPACO
AVORIO

FPL LC 041



MDF LACCATO OPACO
BIANCO

FPL LC 044

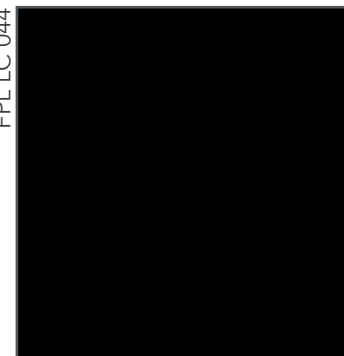

MDF LACCATO OPACO
NERO



aperture

APERTURE

La gamma uni_door offre soluzioni di apertura a battente e a pivot, quest'ultimo è disponibile in due modelli: pivot solution e pivot superior.

BATTENTE

Qualità e efficienza sono le caratteristiche chiave del modello con apertura a battente. Con un valore di trasmittanza termica fino a 0,82 W/(m²K) e una resistenza antieffrazione RC2 e RC3, offrono sia efficienza energetica che sicurezza.

Dimensioni:

Minimo 960* x 1920 mm

Massimo 1150 x 2550 mm

Spessore telaio: Alu Flat: 68 mm – Alu Flush: 80 mm

Spessore anta: 80 mm

Vetrocamera: Triplo Stratificato 3.3.1

Ud: Fino a 0,82 W/(m²K)

* larghezza minima esterno telaio 960 mm valida per modelli in_luce. Su modelli in_ciso, in_serto e in_castro la larghezza esterno telaio minima può arrivare a 860 mm.

PIVOT SOLUTION

Nel modello Pivot Solution la porta ruota attorno ad un asse verticale nascosto, creando un ingresso che esalta qualsiasi design. Perfetta per costruzioni con grandi aperture, si adatta ad una moltitudine di diverse tipologie con pannelli fissi laterali o sopra-luce, unendo eleganza e funzionalità per trasformare il tuo spazio. Sicurezza antieffrazione RC3.

Dimensioni:

Minimo 1000 x 2000 mm

Massimo 1500 x 3000 mm

Spessore telaio: 80 mm

Spessore anta: 80 mm

Vetrocamera: Triplo Stratificato 3.3.1

Ud: Fino a 0,76 W/(m²K)

PIVOT SUPERIOR

Il modello Pivot Superior è un up-grade del modello Solution. Nel modello Pivot Superior la porta è in grado di arrivare ad una altezza massima di 4000 mm con una superficie massima dell'anta di 6 m². Ideale per grandi aperture con altezze elevate, combinabile con sopra-luce e/o fiancoluce cieco o vetrato per raggiungere dimensioni maggiori. Sicurezza antieffrazione RC3.

Dimensioni:

Minimo 1350 x 2050 mm

Massimo 2000 x 3000 mm

XL: Fino a 6 m²

Spessore telaio: 113 mm

Spessore anta: 113 mm

Vetrocamera: Triplo Stratificato 3.3.1

Ud: Fino a 0,64 W/(m²K)

BATTENTE



960 mm



1150 mm

PIVOT SOLUTION



1000 mm

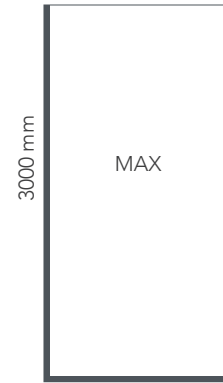

1500 mm

A-B

Total Width
1000 mm
1100 mm
1200 mm
1300 mm
1400 mm
1500 mm

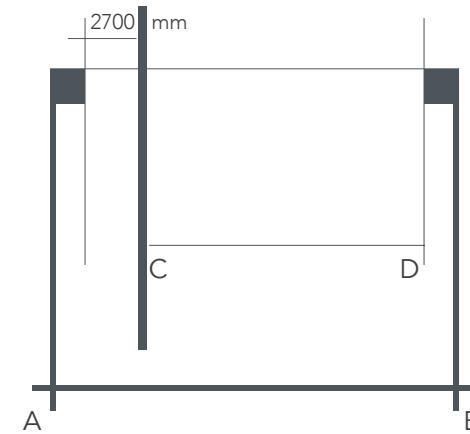

C-D

Clear Opening
730 mm
830 mm
930 mm
1030 mm
1130 mm
1230 mm

PIVOT SUPERIOR

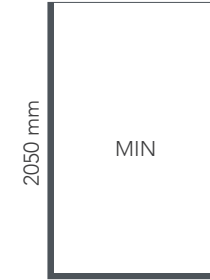

1350 mm

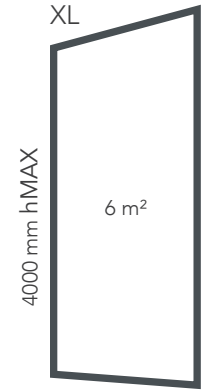



configuratore uni_door

PORTONCINO A BATTENTE

Configura la tua porta ideale scegliendo tra gli oltre 32 modelli esclusivi.

Seleziona la dimensione, il colore e gli accessori che preferisci.

Facile, intuitivo e veloce.

Compatibile con PC, tablet e smartphone.



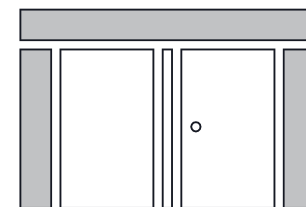
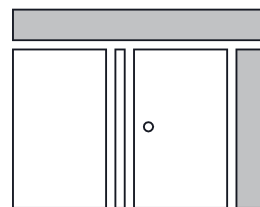
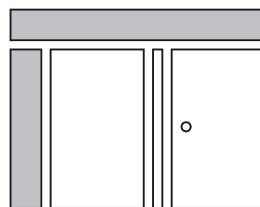
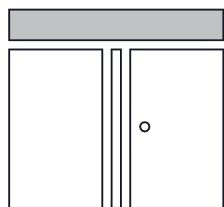
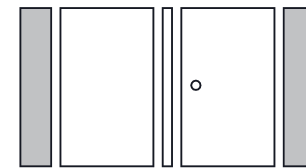
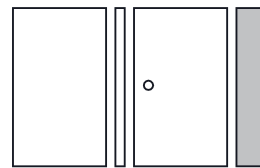
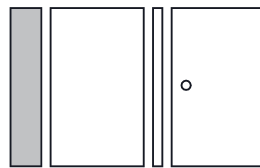
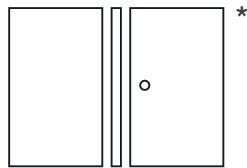
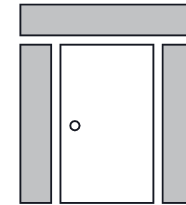
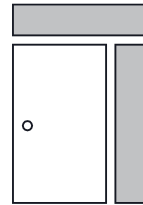
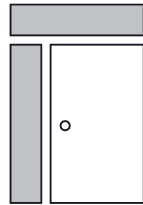
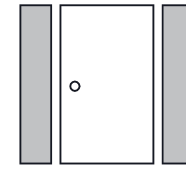
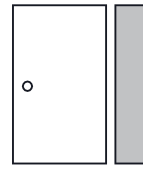
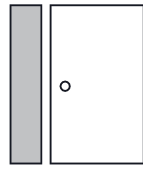
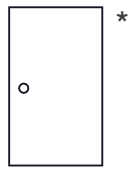



accessori

ACCESSORI

Maniglie, maniglioni, cerniere.

Tutto il necessario per completare la tua porta
e arricchirla con dettagli unici e ricercati.

MANIGLIONI



SQUARE



BLADE disponibile anche orizzontale



BAR



CRYPTO led light calda 4000k fredda 6000k



VISION

Disponibile anche in tinta con il colore del portoncino d'ingresso e con lettore ad impronta digitale.

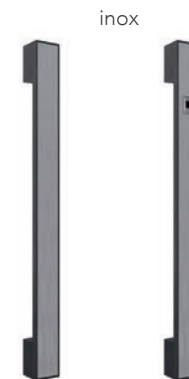

ACCESSORI DIGITALI



SPIONCINO CON DISPLAY



TASTIERINO



SCANNER



SOFT TOUCH

Disponibile anche in tinta con il colore del portoncino d'ingresso e con lettore ad impronta digitale.

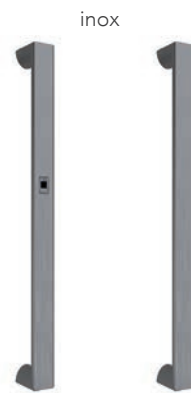



MANIGLIONI BIOMETRICI

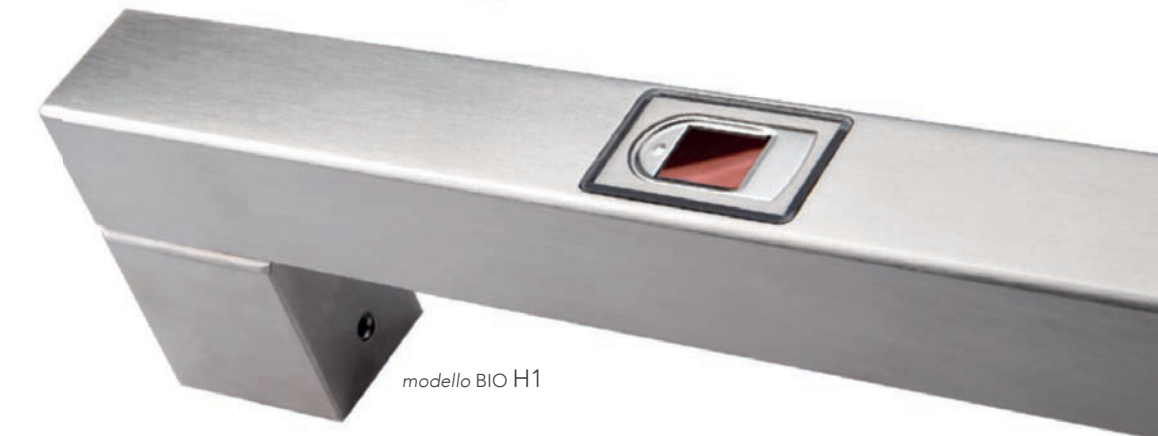
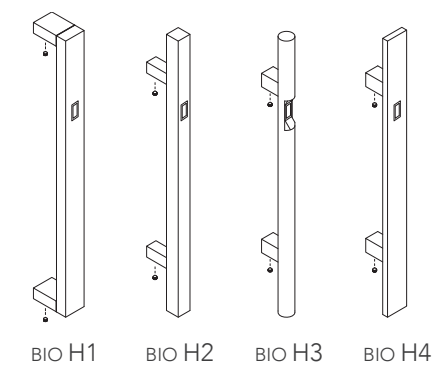

MANIGLIE

INOX 1



inox 1
argento

inox 1
oro matt

inox 1
oro antique

inox 1
nero

CANTO



canto
argento

canto
nero

ATLANTA



atlanta
argento

atlanta
nero

INOX 3



inox 3
argento

inox 3
nero

CILINDRO

CON DOTAZIONE DI CHIAVI



cilindro europeo
- di sicurezza
- di emergenza



cilindro europeo
- con pomolo
argento



cilindro europeo
- con pomolo
nero

ROSETTE

DI PROTEZIONE PER CILINDRO



colori disponibili:
- anodizzato grigio
- nero

FERRAMENTA GU

3 punti
con gancio
*ferramenta
di serie*



3 punti
automatico



3 punti



5 punti



5 punti
automatico



5 punti
automatico
con gancio



CERNIERE

TELAIO FLAT

cerniera
master
a due ali
*cerniera
di serie*



colori disponibili:
- anodizzato grigio
- bianco
- nero
- con supplemento
disponibile anche
in tinte alternative

cerniera
master
a tre ali



colori disponibili:
- anodizzato grigio
- bianco
- nero
- con supplemento
disponibile anche
in tinte alternative

TELAIO FLUSH

cerniera
master
a tre ali



colori disponibili:
- anodizzato grigio
- bianco
- nero

TELAIO FLAT E FLUSH

cerniera a
scomparsa



colori disponibili:
- nero

CHIUDIPIORTA AUTOMATICI

MODELLI A COMPASSO



nero



argento



bianco

MODELLI A SCOMPARSA



ASSA ABLOY:
larghezza fino a 1150mm



ASSA ABLOY:
larghezza fino a 1250mm



RYOBY:
larghezza fino a 1150mm

KIT DI MANUTENZIONE



- Detergente per alluminio
- Detergente per inox
- Umettante per guarnizioni
- Olio lubrificante
- Panno per la pulizia
- Istruzioni per la manutenzione e la cura

SISTEMA DI PORTA

ESPLOSO

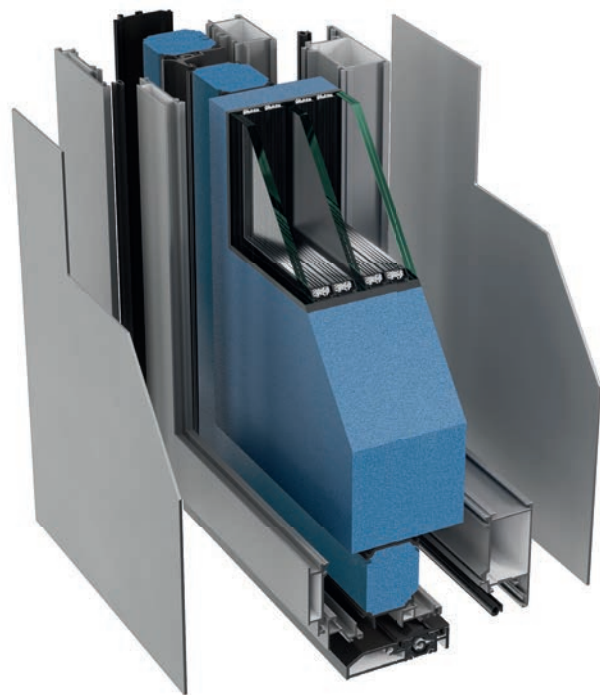

ANTIEFFRAZIONE		RC2 STANDARD
ANTIEFFRAZIONE		RC3 UPGRADE KIT
TRASMITTANZA TERMICA (Ud) VERSIONE CON SOGLIA		0,82 W/(m ² K)
PERMEABILITÀ ALL'ARIA		CLASS 4
RESISTENZA AL CARICO DEL VENTO		CLASS C3/B3
TENUTA ALL'ACQUA		CLASS 3A
ISOLAMENTO ACUSTICO		36 dB
ALTEZZA SOGLIA		15 mm

ALU

TELAIO FLAT



VISTA ESTERNA



VISTA INTERNA

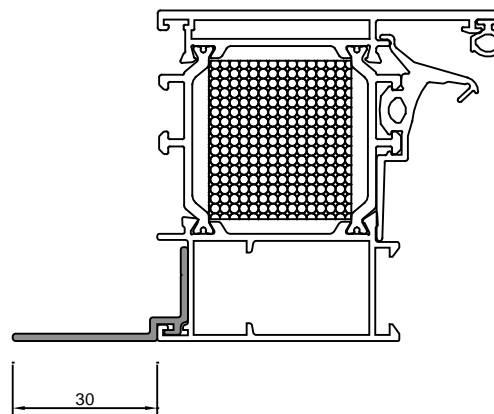
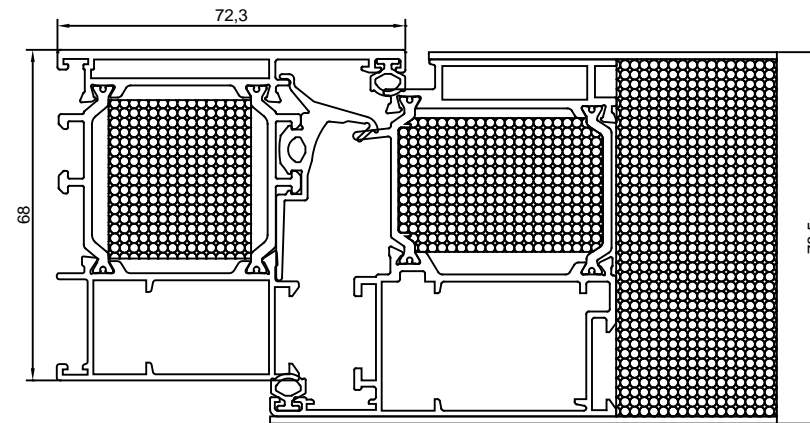

disponibile telaio a Z, con aletta di battuta, da 30 mm

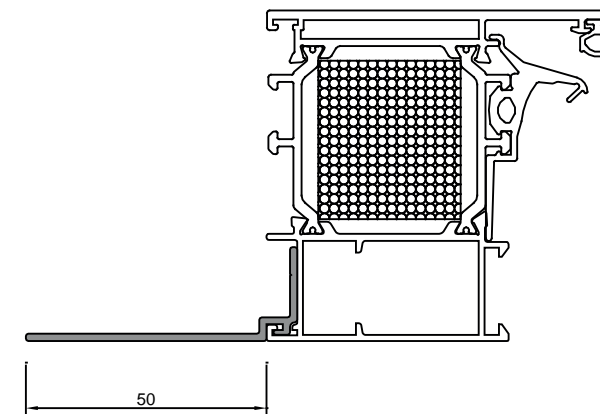

disponibile telaio a Z, con aletta di battuta, da 50 mm

ALU

TELAIO FLUSH



VISTA ESTERNA



VISTA INTERNA

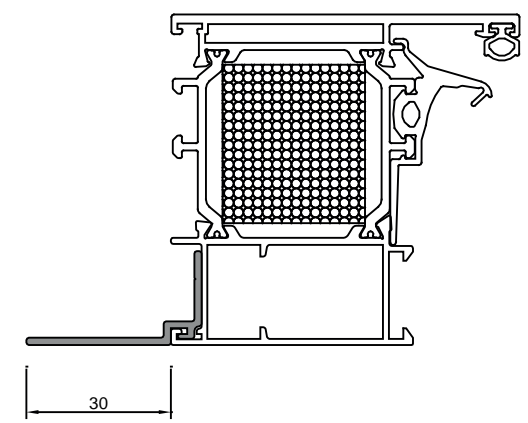
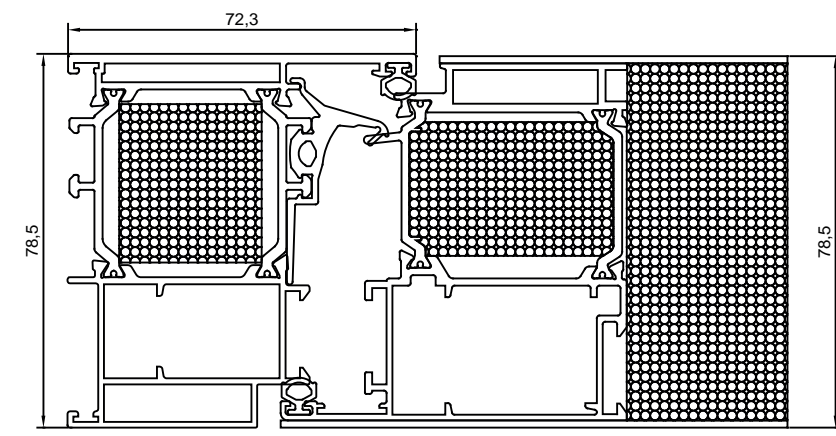

disponibile telaio a Z, con aletta di battuta, da 30 mm

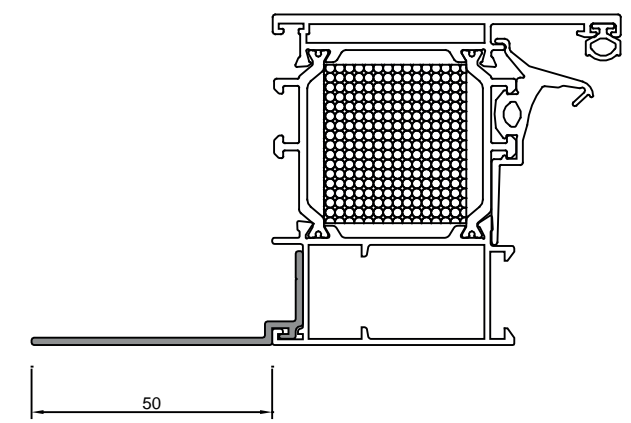

disponibile telaio a Z, con aletta di battuta, da 50 mm

WOOD-ALU

TELAIO FLAT

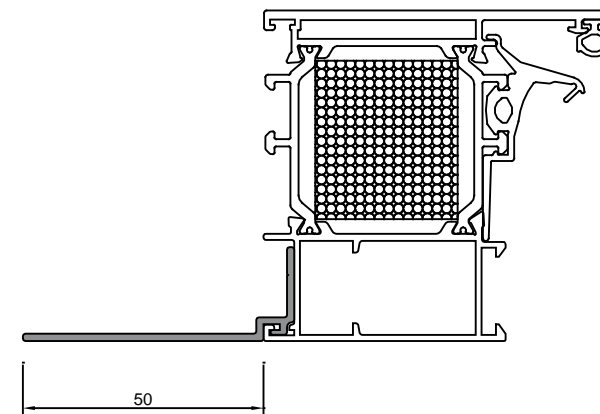
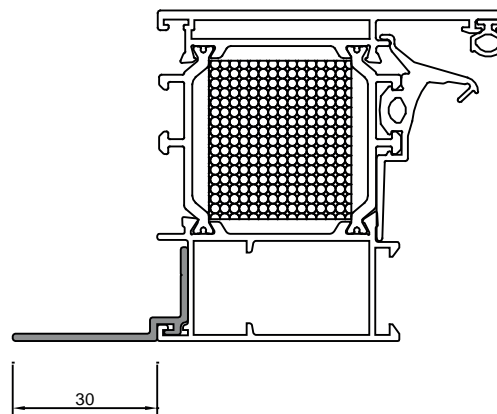
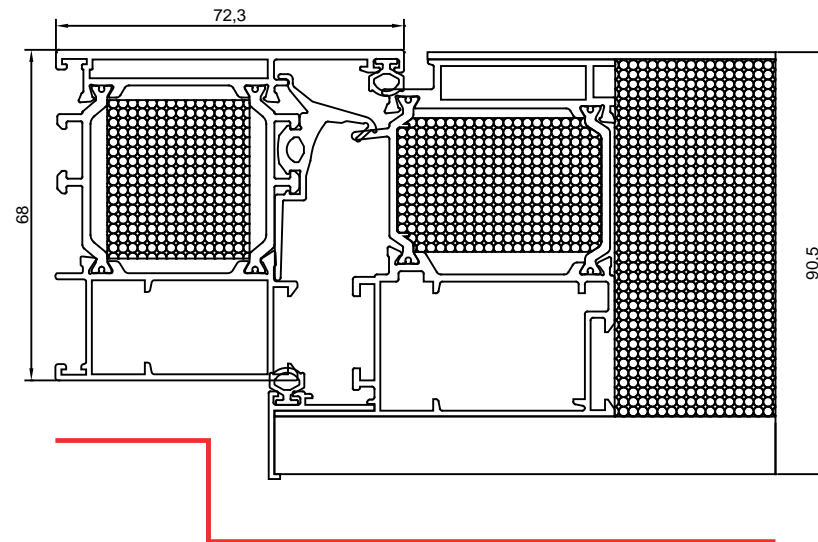
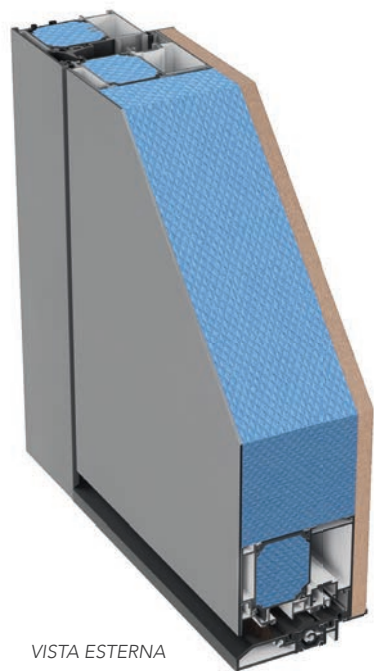

disponibile telaio a Z, con aletta di battuta, da 30 mm

disponibile telaio a Z, con aletta di battuta, da 50 mm

Finiture ALLUMINIO

TRENDY

ST2 W353F

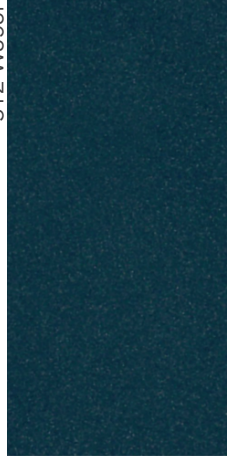

ST2 J323F



ST2 2306I



ST2 2373I



ST2 4304I



ST2 4307I



ST2 W373F



ST2 W365F

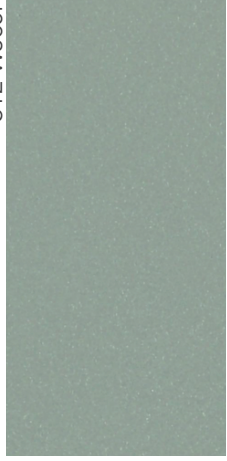

STANDARD STRUCTURA

RAL9010

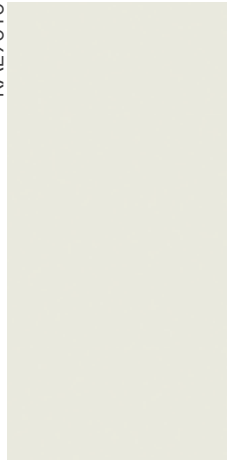

RAL9016

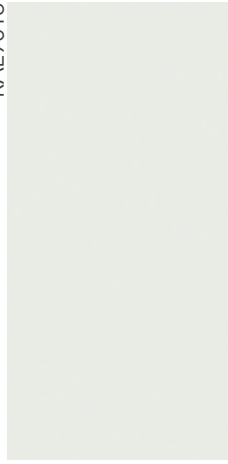

RAL7035



RAL7001

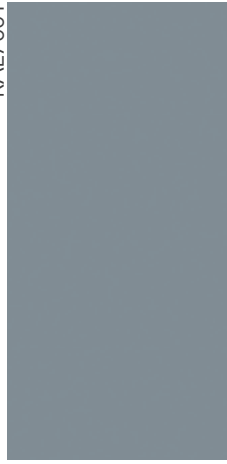

RAL7016

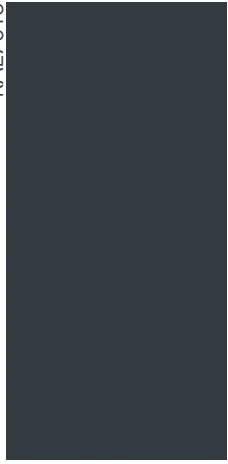

RAL6005



RAL3004

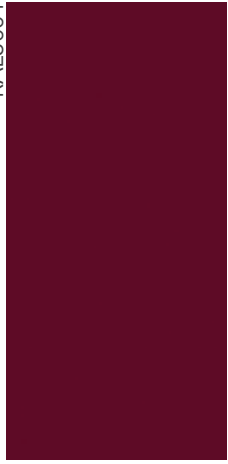

RAL8017

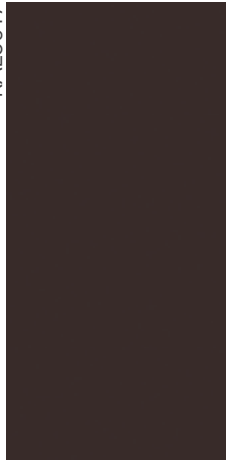

RAL STRUCTURA



DECORATI LEGNO



RIASSUNTIVO COLLEZIONI

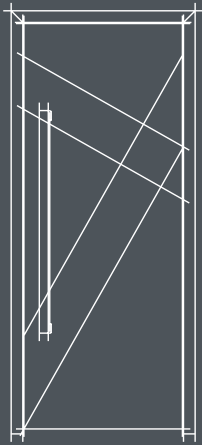

40102

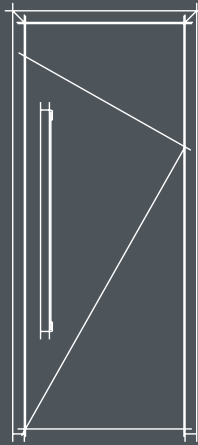

40101



40105

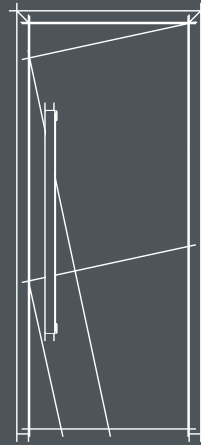

40104

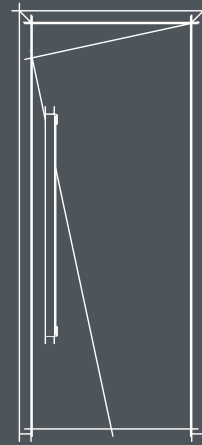

40103

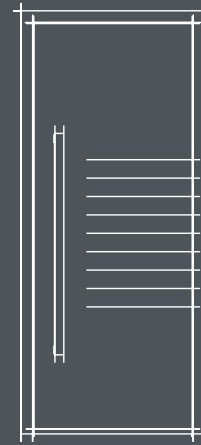

40106

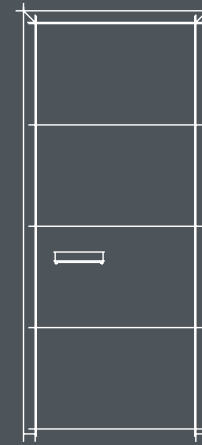

40107

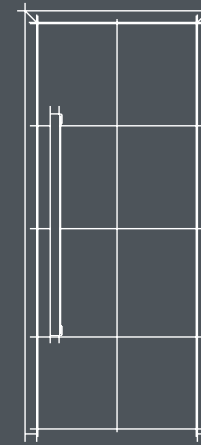

40108

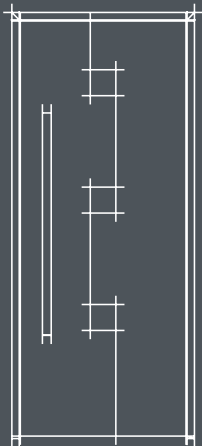

40109

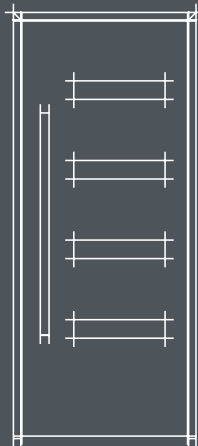

40111

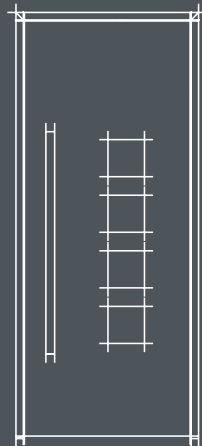

40112

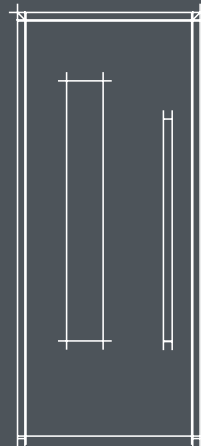

40113

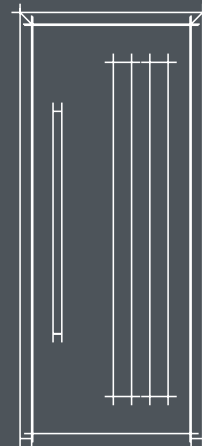

40114

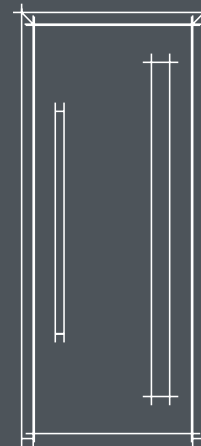

40115

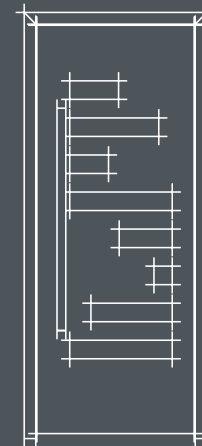

40116

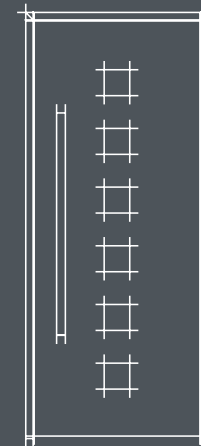

40110



40117

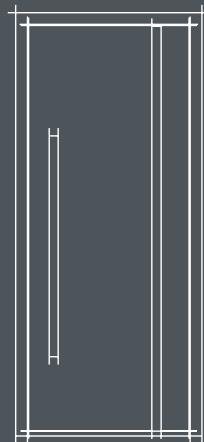

40118

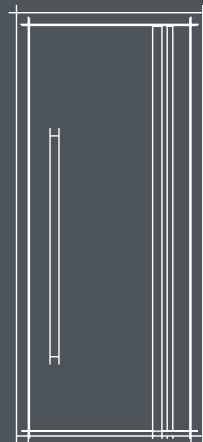

40125

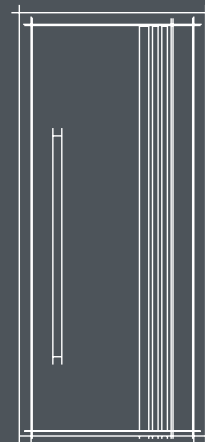

40119

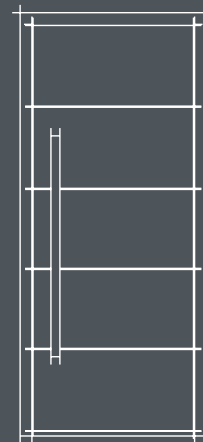

40120

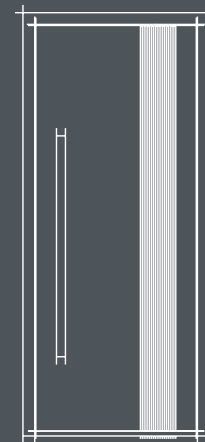

40126

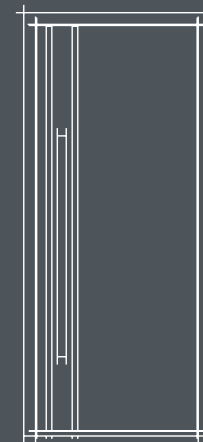

40121

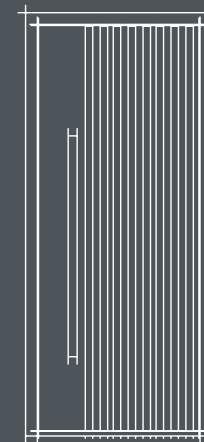

40124

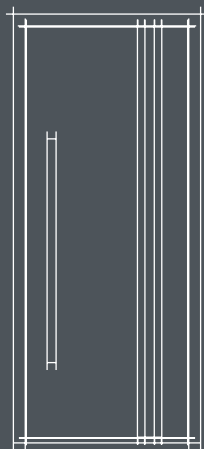

40135

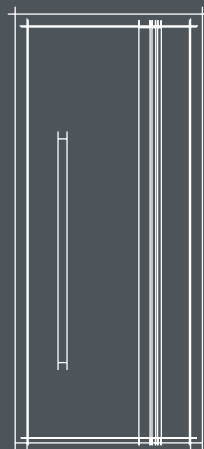

40134

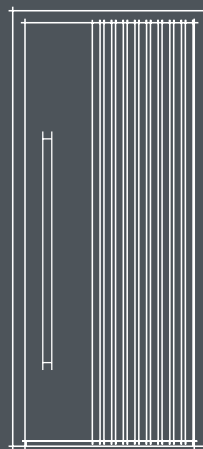

40133

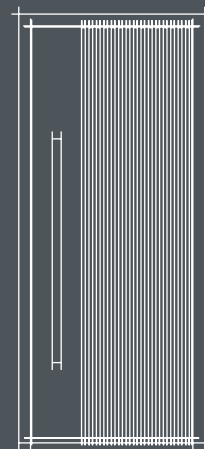

40132

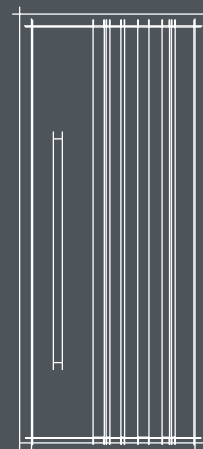

40131

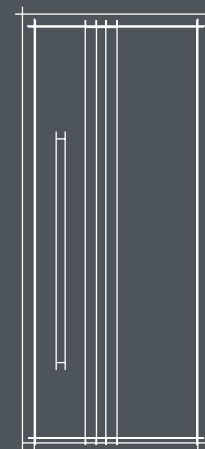

40129

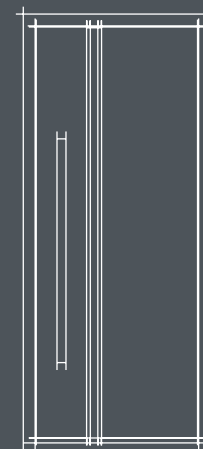

40127

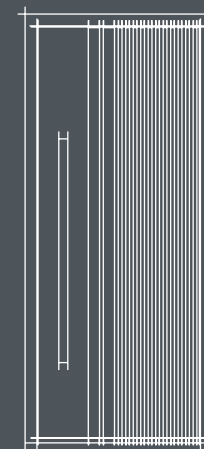

40128

uniform
thewindowmotive®

via dell'Agricoltura, 36
37046 Minerbe - Verona, Italy
tel +39 0442 669669
uniform@uniform.it

